

# GENESIS® T8 SERIES WITH PLM INTELLIGENCE™

T8.320 | T8.350 | T8.380 | T8.410 | T8.435



**PLM**  
NEW HOLLAND INTELLIGENCE



# Innovation meets intuition.

---

New Holland built the new GENESIS® T8 Series with PLM Intelligence™ around the input of operators like you. From a reimagined cab designed to offer the most comfortable and convenient driver experience, to next-generation intuitive controls that can be easily customised to the tasks at hand, every detail has been carefully engineered to meet your needs.

The new GENESIS® T8 is also the first tractor on the market to fully integrate New Holland's advanced PLM Intelligence™ platform. So, no matter where you are, you're always connected to real-time insights, information, and support.

All of these advances and innovations have evolved to create the most intuitive tractor the field has ever seen.





### Your partner in the field

Technology will continue to evolve over time, but farming will always depend on a foundation of community and connection. The new GENESIS® T8 with PLM Intelligence is designed to strengthen and reinforce those bonds, bringing together the people and innovations that make modern agriculture possible.

- **Customer-to-Vehicle Connectivity** - allows you to run your farm business from the cab, the farm office or the other side of the world.
- **Dealer-to-Vehicle Connectivity** - helps you minimise downtime with proactive support, remote monitoring, diagnostic, and in-field software updates.
- **Advisor-to-Vehicle Connectivity** - lets you stay in touch with agronomists and other experts to improve decision-making on the move.

## MYPLMCONNECT

### MyPLM™Connect telematics free for 5 years

Assisting fleet managers to optimise machinery management. Providing real-time field data at your fingertips. Enabling accurate data management to improve operating efficiency. This all now comes as standard across the entire GENESIS® T8 lineup, with MyPLM™Connect with file transfer. What's more, in order to improve your uptime, New Holland's Breakdown Assist service has been fully integrated, free of charge.

### GENESIS® T8 wheeled offering



Models	Rated (hp)	Wheelbase in. (mm)	Weight lbs. (kg)
T8.320	250	136 (3454)	25,045 (11,360)
T8.350	280	136 (3454)	25,045 (11,360)
T8.380	311	136 (3454)	25,045 (11,360)
T8.410	340	136 (3454)	25,221 (11,440)
T8.435	380	140 (3555)	28,746 (13,039)

### GENESIS® T8 SmartTrax™ offering



Models	Rated (hp)	Wheelbase in. (mm)	Weight lbs. (kg)
T8.410	340	136 (3454)	36,376 (16,500)
T8.435	380	140 (3555)	36,376 (16,500)

### The right model for your business

Selecting the right GENESIS® T8 tractor for your business is made easier thanks to New Holland offering a choice of power output, transmission type and both wheeled and versatile half-track SmartTrax options. Your New Holland dealer can help you choose options to include front hitch and PTO packages, cab and front axle suspension, a choice of work lights, in-cab refinements and, of course, fully integrated IntelliSteer™ guidance packages. With New Holland, choice comes as standard.



# Connected for the way you work.

## Customisable control

When the time comes to deliver precision results in the field, there's no room for a "one-size-fits-all" approach. Every operator has their own unique preferences and requirements. So, we built your controls package around the revolutionary idea that custom adjustments should come standard.

## Improved visibility

Whether you're in an open field or on a busy road, awareness of your surroundings is essential. We've reduced in-cab obstructions, placed your InfoView™ dash display in direct line-of-sight and even installed front hood mounted and rear facing cameras for road safety and in-field work. With two premium lighting packages to choose from, you can turn night into day.

## Enhanced comfort

With all the hours you spend in the field, shouldn't work feel a little more like home? We think so. That's why we've added more accessible storage, USB power ports, a powerful two-zone HVAC system, egress lights, and the most comfortable seat outside of your living room.

## Advanced support

When you drive a tractor that measures productivity and precision in seconds and millimeters, you have no patience for "downtime." Introducing MyPLM™Connect, which lets you stay in touch with your machines at all times, from anywhere. We have incorporated remote connectivity with New Holland Remote Assistance, advanced diagnostics, IntelliView™ Connect remote display viewing, and software updates.

## Intuitive simplicity

True innovation doesn't require an advanced degree to operate. To help you harness all of the powerful features and technologies built into the new GENESIS® T8 tractors, we developed a user-friendly interface that feels as natural and instinctive as agriculture itself.

Modern aggressive styling package

Trademark cat's-eye lights

170° front hood camera and rear cab pillar camera

Optional fully integrated front hitch with 1000-speed PTO

Terraglide™ front suspension

FPT Industrial Cursor 9 engine featuring Tier 2 Engine technology with up to 435 maximum horsepower

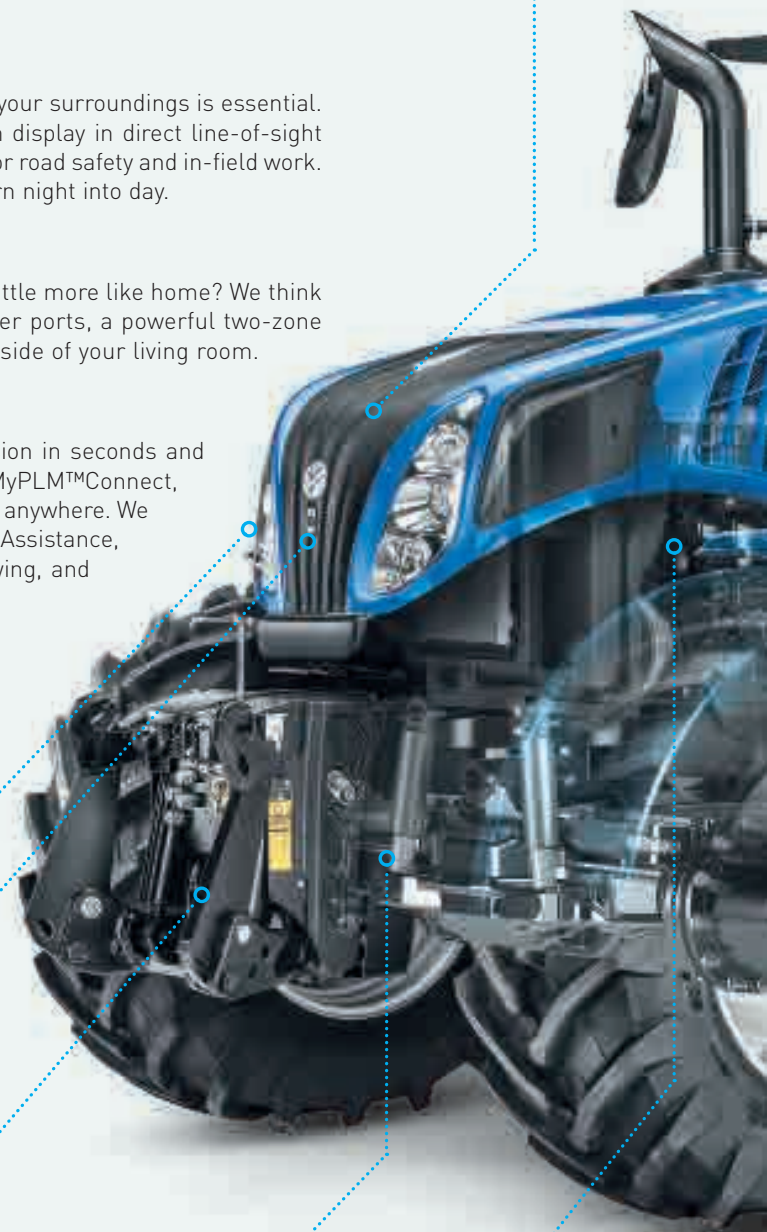



# PLM

NEW HOLLAND INTELLIGENCE



Factory-installed IntelliSteer™ guidance system

5-year MyPLM™Connect Advanced package telematics subscription comes standard

Up to 24 LED working lights

All new SideWinder™ Ultra armrest and IntelliView™ 12 monitor

Advanced seat options

Optional semi-active Comfort Ride™ cab suspension

10 in-cab storage spaces

Wide, full-width opening door for easier access and enhanced visibility

Headland Turn Sequencing II (HTS II) system

Tyre pressure monitoring system

Tight-turning brake-assisted steering feature

Proven Ultra Command™ transmission or advanced Auto Command™ transmission

New fast-turning CustomSteer™ feature

## Exclusive Blue Power Edition.

---

The Blue Power model was developed for agribusinesses that value the ultimate in premium performance, cutting-edge technology, and comfort — not to mention stylish good looks. If you want your tractor to stand out in the field, the Blue Power GENESIS® T8 with PLM Intelligence™ is your answer.





*Blue power*



**Blue Power: Exclusive edition, exclusive emotion.**

- Distinctive and eye-catching metallic midnight blue paint
- Chrome coloured grille
- Silver wheel rims
- Silver 3D decals
- Blue Power roof insignia
- Available on all GENESIS® T8 Auto Command™ models
- Blue Power-branded black thick-pile cab carpet

# Experience a revolution in tractor operation.

An ergonomic, spacious and practical operator environment is a must for day-long productivity. That is what New Holland's industry-leading GENESIS® T8 cab delivers. Want all-around visibility? Whether you're in the yard, in the field or on the road, you'll have an uninterrupted, productivity-enhancing view. Always. The ultra-wide opening door facilitates access for easier entry and exit.



## Enhanced comfort

The GENESIS® T8 range's steering wheel now has separate tilt and telescopic adjustment as standard, which makes it even easier for operators to select a comfortable working position — invaluable when spending long hours in the field or on the road.



## Front and rear sun visors

The front and rear sun visors have been fully integrated into the cab design, so that when they are not in use you have a clear view. They can be pulled up and down from the comfort of the seat without stretching.



## Intuitive climate controls

The entire air-conditioning system has been redesigned, with a powerful two-zone cooling system and precision positioned vents to ensure whole body comfort. All controls have been ergonomically relocated to the SideWinder™ Ultra armrest, making on-the-go adjustments even easier.



## Stay refreshed on the hottest days

The optional portable cooler mounted to the right of the operator seat can be easily removed for replenishment.







### Eyes in the back of your head

The standard enlarged wing mirrors feature an adjustable top section for the best possible view of the road during high-speed transport. The adjustable lower section has been designed to effectively counteract blind spots. Additional options include heated wing mirrors, which electronically extend laterally to enhance visibility when working with the widest loads.

Thanks to a laminated front windshield, thicker rubber window and door seals, thicker floor mat and even more insulation under the cab floor, the new GENESIS® T8 cab is quieter than ever.





## The ultimate in farming comfort.

---

New Holland brings you superior seating, with two different models to choose from — Auto Comfort™ and Dynamic Comfort™ seats. All seats benefit from improved cushioning. These firmer, more durable seat cushions provide outstanding operator comfort, whatever the terrain.





### Auto Comfort™ seat

The ventilated Auto Comfort™ seat offers a premier seating experience. With automatic weight compensation, active suspension, heating and even a ventilation system that cools and removes moisture, this is perfect for operators who spend extended hours in the tractor. The seat is trimmed in blue and grey leather.

### Dynamic Comfort™ seat

The Dynamic Comfort seat boasts an enhanced low-frequency suspension mechanism. The stitched cushions, finished in a stylish cloth, also feature two-stage heating.

### Plenty of room for all

A standard, full-size upholstered instructor seat folds down to provide a work surface when not in use.



	Dynamic Comfort™ seat	Auto Comfort™ seat	Blue Power Auto Comfort™ seat
Material	Cloth	Leather	Leather
Suspension type	Low-frequency with dynamic damping	Semi-active	Semi-active
Damping system	Automatic	5 modes	5 modes
Weight adjustment	Automatic	Active electronic	Active electronic
Lumbar support	Pneumatic	Pneumatic	Pneumatic
Climate System	2-stage heater	Heating and active ventilation	Heating and active ventilation
Passenger seat	Cloth	Leather	Leather

## Bright lights for dark nights.

Lighting up the way for improved night-time productivity and total safety is a key New Holland priority, accomplished by bringing into the farming world the latest automotive sector innovations, such as LED lights. The lighting offering features up to 24 LED lights. Brighter and consuming less power than their standard equivalent, these lights offer a broad spread of white light, turning night into day. When the premium package is specified, this delivers 49,400 lumens, which is over 30% more light than the previous T8 lineup. Up to 6 lights can be fitted to the front and up to 8 lights can be fitted to the rear of the roof, while high-level headlamps light up the distance and pave the way for non-stop operation.

49,400 LUMENS — over 30% more light than previous T8 lineup





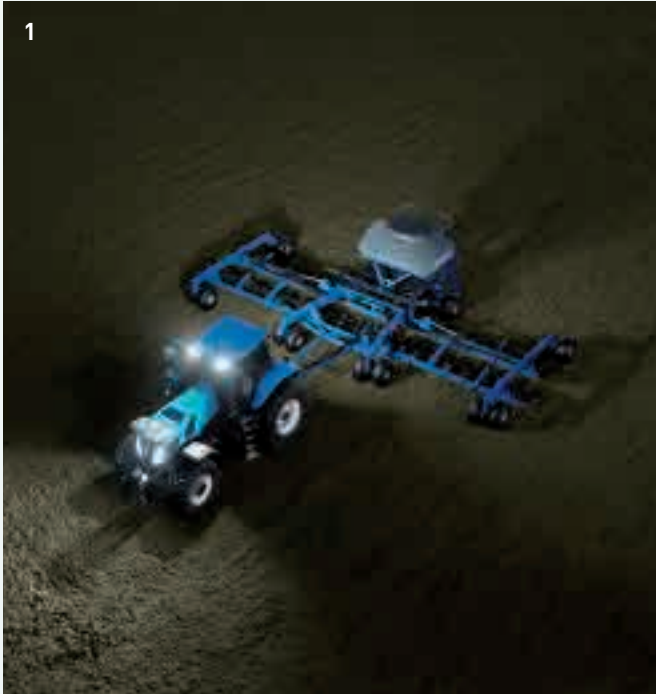

Two cab LED lighting packages are available, including Level 1 with 18 lights (photo 1), and Level 2 with 24 lights (photo 2). Both come in various configurations to suit your individual requirements.



### Fully adjustable lights

The optional 360° package includes an adjustable light at each corner of the cab. Customisable on-off lighting combinations are available, and activated via two lighting memory switches, that can turn on/off banks of lights — ideal when working alongside a combine harvester, for example.

LED lights define efficiency itself: more light, more durability, less power consumption.

# SideWinder™ Ultra: the ultimate ergonomic farming experience.

GENESIS® T8 tractors offer sophisticated features that are easy and intuitive to access. The SideWinder™ Ultra armrest hosts all key controls, including throttle, transmission and hydraulics. Everything you need to control is intuitively selected. More advanced features can be quickly accessed.



## Customisable buttons

Up to 11 buttons can be personalised and configured on the SideWinder™ Ultra armrest. Located in strategic positions around the armrest: one on the multifunction handle, two on both the joystick and main keypad, four on the rear keypad, and one or two on the throttle/transmission keypad (depending on the transmission option selected). These buttons can be configured to suit both the task at hand and the specific preferences of the operator.



## Adjustable SideWinder™ Ultra armrest

The SideWinder™ Ultra armrest can be adjusted to suit your specific requirements. Two manual levers adjust both the height and front/back position of the armrest for enhanced ergonomic operation.



Front or rear hitch control selector

Thumb wheel for position / draft setting

CommandGrip™ handle

STOP button to disengage hydraulics, PTO and hitch

Fingertip control for up to two remote valves

Front and rear hitch raise/lower

Headland Turn Sequencing II (HTS II). Press to record, store and activate automated headland turn

Forward / reverse shuttle and neutral buttons

IntelliSteer™ auto-guidance, automated steering engagement

1 of 11 configurable buttons

Fast raise, lower and dig buttons

Store depth button

Position or draft selector

Main tractor functions shortcut buttons

Terralock™ engagement for automatic management of four-wheel drive and differential lock selection

Light configuration buttons

Three stage acceleration and deceleration setting

1 of 11 configurable buttons

Stored Engine Speed Management settings 1 and 2

Ergonomically positioned hand throttle





### Optional 2-lever hydraulic remote pod



Multifunction joystick can be set to operate the front hitch or remote valves

Tractor speed increase / decrease

Forward / reverse shuttle switch

2 configurable buttons

Configuration screen shortcut button

Screen back button

Phone, radio and media controls

Climate controls

Intentional PTO switch, which must be selected to keep the PTO engaged when leaving the operator seat

Engage and disengage the front and rear PTO instantly

Auto PTO will disengage and re-engage both the front and rear PTOs during a headland turn

5 configurable hydraulic valve levers

Thumb wheel encoder

Sliding padded armrest can be adjusted for increased elbow support when using the joystick or CommandGrip™ handle

Front and rear hitch limits settings

4 of 11 configurable buttons

# Intelligent monitors for intelligent agriculture.

The all-new IntelliView™ 12 monitor delivers a wide range of machine benefits at your fingertips. A clear evolution from the former IntelliView™ IV, the new “12” model – with its sleek, automotive style “dash” styling, intuitive display and modern design – will become the benchmark of the future.







### Fully customisable

In the IntelliView™ 12 monitor's standard operational layout, the screen is divided into four main areas:

- The top bar allows the operator to access tractor and operation settings.
- The run screens are located on the bottom bar and are customisable and always accessible.
- The main part of the screen is composed of the user-selected run screens, which show key parameters related to the task at hand.
- The left-hand side is another user definable window, which contains primary operating parameters such as fuel rate and slip.



### InfoView™ dash display

The large LCD flat screen display positioned directly in front of the steering wheel is your "at a glance" machine dashboard. It features a host of key operating parameters such as engine rpm, forward speed and selected gear.



### Perfect view

In order to enhance transport safety, a viewing camera has been integrated into the hood. When approaching a traffic junction, this enables you to "see forward" for improved road safety. An additional advantage is that you have a perfect view of front-mounted implements, both while working in the field and when connecting in the yard.

# Three factory-fitted guidance packages.



When ordering your GENESIS® T8, you can choose between three different guidance packages. This means that your GENESIS® T8 will arrive direct from the factory with the exact accuracy level you require. Choose your accuracy level right down to the most precise 1 inch\* option, which is extremely beneficial for precision arable applications, especially in high-value vegetable or bulb farming.

\* Using PLM RTK or PLM RTK+ correction signal





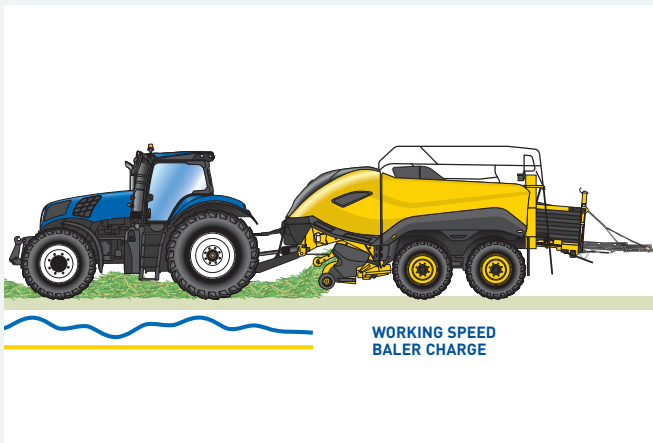

### Two-way communication

The GENESIS® T8 Series is fitted with ISOBUS II as standard or optional ISOBUS III technology. ISOBUS III means the tractor and implement can communicate with each other, relaying information back and forth, resulting in the implement controlling the speed of the tractor to achieve maximum productivity.

When connected to a New Holland BigBaler this enables the IntelliCruise™ feature, which controls the tractor's forward speed to increase productivity, improve operator comfort, improve fuel savings and optimise feeding rates in varying field and crop conditions. This system has two running modes: Charge Control Mode for maximum capacity or Slice Control Mode to consistently obtain the desired number of slices per bale.



### Choose three accuracy levels

New Holland offers customers the choice between three differing levels of accuracy:

1. PLM 1 = 6 in. accuracy
2. PLM 2 = 2 in. accuracy
3. PLM RTK & PLM RTK+ = 1 in. accuracy



### PLM Cygnus receiver

The new PLM Cygnus Receiver delivers improved machine position thanks to its integrated terrain compensation technology. It also enables quicker convergence times, as well as enhanced reliability in challenging conditions such as when working in valleys and in heavily forested areas.

# Connected vehicles for efficient farming.

## MYPLM<sup>™</sup>CONNECT

### Connected. Productive. Efficient.

Agriculture is constantly evolving, and split-second decisions have an enormous impact on your business' profitability. New Holland's goal was to place farm managers and contractors in every field, even when they are sometimes hundreds of miles away. This is now possible thanks to MyPLM™Connect. Using mobile telephone technology, users receive dynamic, real-time information on every machine working in their field and can analyse that data to make correct decisions for each and every machine, in each and every field.

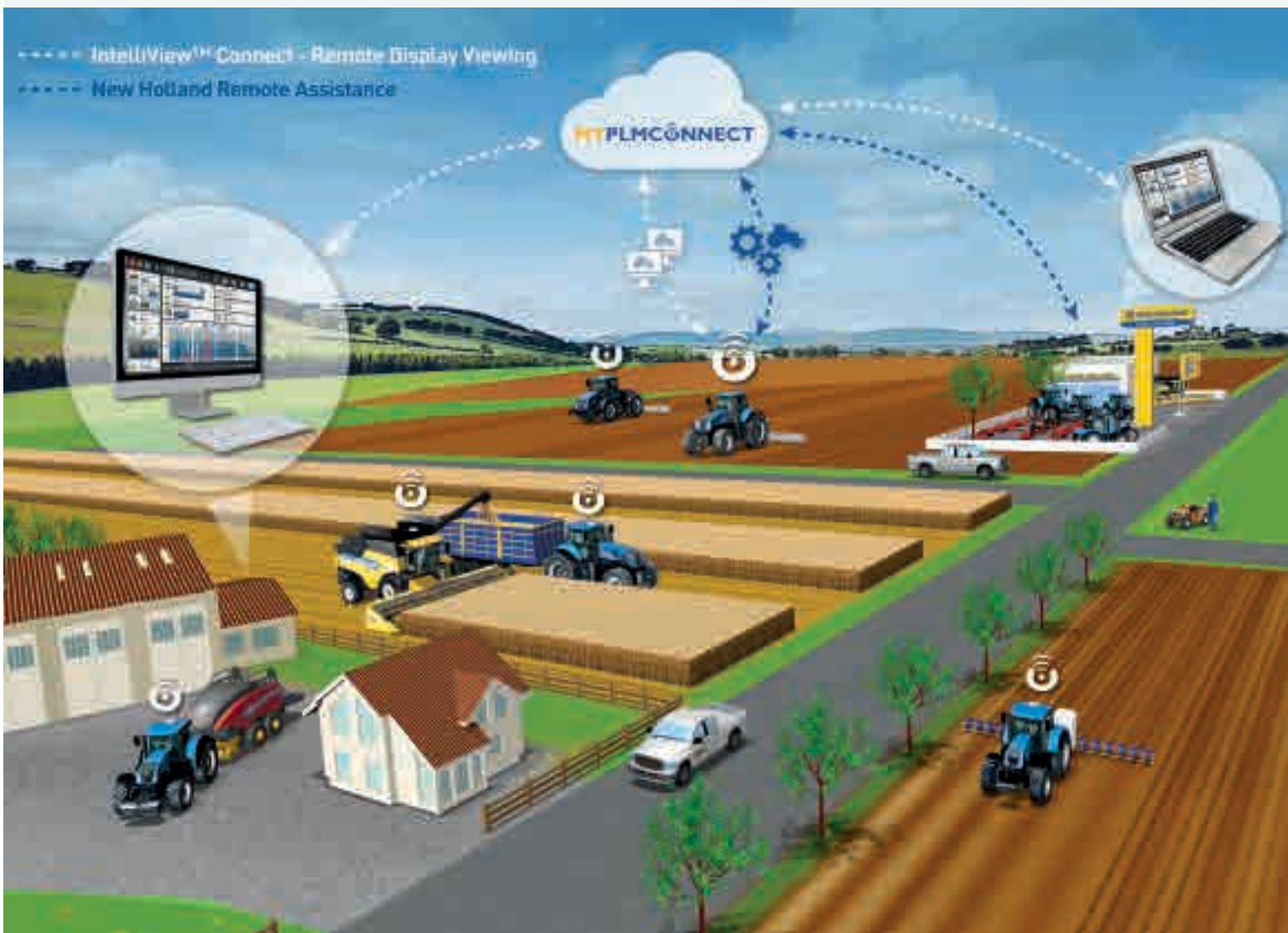

### Telematics: Manage your machine from the comfort of your office

MyPLM™Connect enables you to connect to your GENESIS® T8 from the comfort of your office through your mobile network. You can stay in touch with your machines at all times, and you can even send and receive real-time information that saves time and enhances productivity. The entry-level MyPLM™Connect Essential package offers the most frequently used features, or upgrade to the MyPLM™Connect Professional package for full machine monitoring and control. In short, MyPLM™Connect will help you to reduce your fuel bills and improve fleet management and security in one simple package.





### MyPLM™Connect Advanced package free for 5 years

Assisting fleet managers to make right time decision. Providing real time field data at your fingertips. Enabling accurate data management to improve operating efficiency. It all comes standard on GENESIS® T8 tractors with MyPLM™Connect. What's more, in order to improve your uptime, New Holland's Breakdown Assist service has been fully integrated, free of charge.



### Access to MyPLM™Connect Portal through MyNew Holland™

MyNew Holland™ provides owners and users the ability to view and manage their machinery fleets online. Users will be able to access a range of information, such as operator manuals and how-to videos as well as an option to view activations and subscriptions via the live link to the VMS tool. Users can even make purchase requests direct with their dealer to activate a service or takeout a subscription. MyNew Holland™ also provides direct access to the MyPLM™Connect Portal.



### Advanced support

When you're operating a tractor that measures productivity and precision in seconds and fractions of an inch, you have no patience for "downtime". With MyPLM™ Connect you can stay in touch with your machines at all times, from anywhere. We have incorporated remote connectivity to provide New Holland Remote Assistance, advanced diagnostics, IntelliView™ Connect remote Display Viewing and software updates.

#### Customer-to-Vehicle Connectivity

Allows you to run your farm business from the cab, the farm office or the other side of the world.

#### Dealer-to-Vehicle Connectivity

Helps you minimise downtime with proactive support, remote monitoring and diagnostics and in-field software updates.

#### Advisor-to-Vehicle Connectivity

Let's you stay in touch with, agronomists and other experts to improve decision-making on the move.



### PLM® Certified Dealers

In order to deliver top-quality service and support, New Holland has developed the PLM® Certified Dealer program. Wherever you see this logo, you're sure to find experts to support your PLM® investments.



# Power and efficiency you've come to expect.

---

The 8.7-litre FPT Industrial Cursor 9 engines, featuring Tier 2 technology, continue to set the standard for engine performance, dependability and efficiency. When it comes to fuel efficiency, GENESIS® T8 Series tractors lead the way. Paired with long, 600-hour service intervals, these engines will maximise your productivity.





**Powered by FPT Industrial**

New Holland is not going it alone when it comes to engine technology. We can draw on the experience of our in-house engine development group: FPT Industrial.



**Pioneers:** Fiat invented Common Rail technology in the 1980s and brought it to the masses in 1997 on the Alfa Romeo 156. They were the very first to introduce it on agricultural machines on the TS-A tractor. Pioneering. Always.



**Engine Power Management explained**

With EPM, the engine develops more power and torque according to the load on the transmission, hydraulics and PTO. On a T8.350 tractor, EPM will deliver up to 71 extra horsepower, but only when it is needed, to maintain performance.

- Rated hp: power produced at rated engine speed.
- Max. hp: power the engine can develop, in the working range.
- Rated EPM hp: maximum power the engine can develop using EPM when conditions allow, at rated speed.
- Max. EPM hp: maximum power the engine can develop using EPM when conditions allow, in the working range.

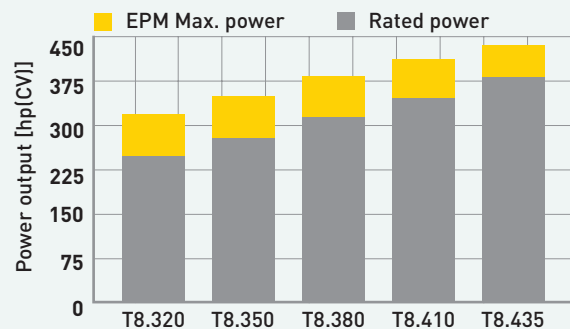

**All the power you need always available**

At New Holland we're passionate about transient response. You might think so what, but it's your productivity guarantee. Put simply, as your Cursor 9 engine only breathes clean fresh air it can react even quicker when placed under load. Significantly quicker in fact. Transient response. We've got it covered.

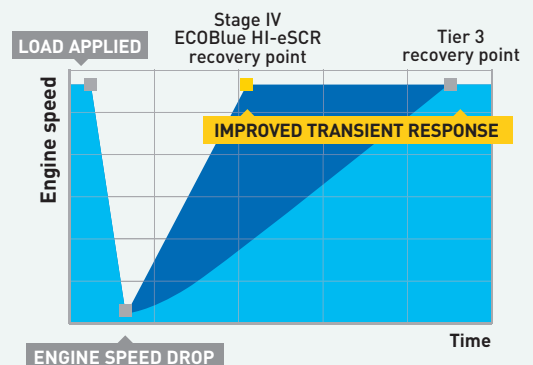

# Full Powershift Ultra Command™ for rugged efficiency.

---

Ultra Command™ full powershift transmissions match proven mechanical efficiency to New Holland ease of control. The result? A transmission that is easy to set up and operate with a speed to perfectly match every application. It's one of the most efficient full powershift transmissions available today. Available on the T8.320 – T8.410 models, the CommandGrip™ handle provides fingertip access to automated features, including Ground Speed Management. Choose between 18x4 and 19x4 (25 mph ECO or 31 mph) direct drive.





## GSM. Intelligent automation

New Holland Ground Speed Management, GSM, is more than just an automated transmission shift system. With CVT-like functionality, it uses a combination of data relating to engine load, forward speed and operator setting to manage both engine and transmission speeds to optimise performance and economy. Simple to set up and extremely efficient, GSM is proven and dependable.

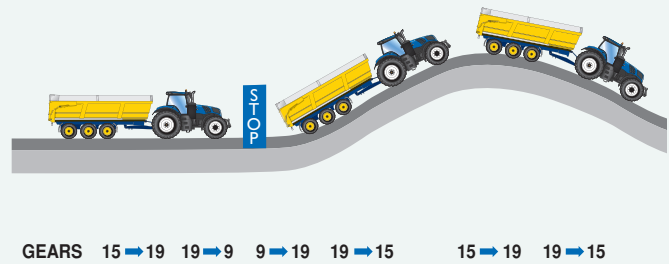
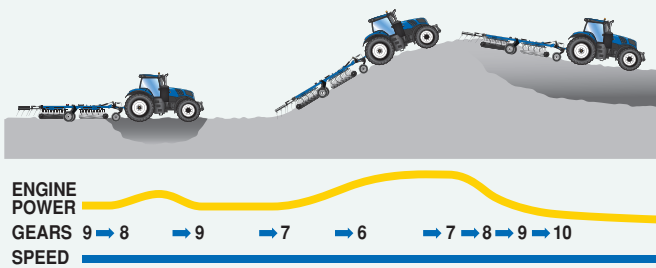

### Fixed forward speed? GSM takes care of it

When load conditions change in the field, GSM will automatically maintain a fixed forward speed. The operator first sets the desired working speed and then selects the GSM function. The automated system will then match engine and transmission speeds to maintain this fixed forward speed, delivering the perfect balance between maintaining productivity without compromising economy.

### Full command in transport

During road transport, GSM will automatically shift the transmission according to load and throttle settings. Starting from your pull-away gear, GSM will auto-shift the ratio all the way to your top speed.



### IntelliView — gear and speed at a glance

The standard IntelliView™ 12 monitor is configurable to provide a dedicated information panel to the left side of the screen, giving a clear read out of the selected transmission ratio and tractor speed.



### Ultra Command™ Powershuttle

The forward reverse shuttle is operated via the steering column or the CommandGrip™ handle fitted on the SideWinder™ Ultra armrest. It can be programmed to automatically manage transmission shifts during a direction change to match or alter forward and reverse speeds. You can use the shuttle lever to easily engage the park lock for added safety.



# Innovative Auto Command™ transmission offers advanced New Holland features.

New Holland has designed and built more than 25,000 multi-award-winning Auto Command™ continuously variable transmissions (CVT). The Auto Command™ transmission benefits from four direct drive points with 100% mechanical efficiency. These points have been precision engineered to ensure that they perfectly match the most frequently used speeds during heavy draft work, secondary cultivation activities, high-speed in-field work, such as baling or mowing, and high-speed transport activities. Advanced double-clutch control further enhances efficiency. Quite simply, it is the smoothest and most productive CVT around.

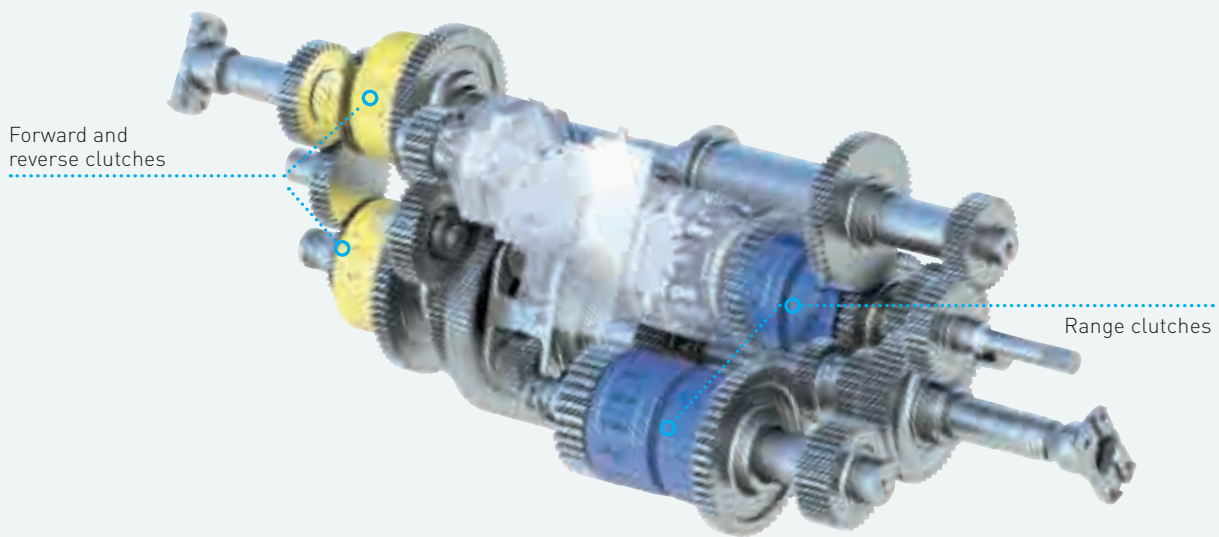

Force-based movement enables the operator to change speed and direction. Forward speed can also be controlled using the foot pedal.

Target speed adjustment — set a target speed to match your exact needs.

Target speed selection — allows you to change between three target speeds.

#### 4 driving modes to suit your driving style:

**Auto Mode.** Once the desired target speed is achieved, Auto Command™ will match the engine and transmission to maintain it.

**Cruise Mode.** Cruise Mode allows the operator to achieve a set target speed at the touch of a button, and to maintain the speed for economy and productivity.

**Manual Mode.** Allows the operator to manually set the required engine and forward speed, independently of each other.

**PTO Mode.** As soon as the PTO is engaged, Auto Command™ will operate to achieve a constant engine speed.





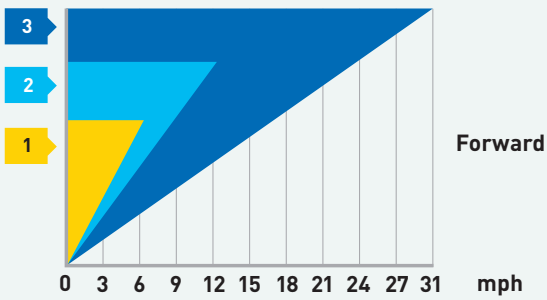

### Three adjustable target speeds for every need

Auto Command™ technology allows the operator to set a target speed of between 0.01 mph right through to 31 mph and regulate it to the nearest 0.006 mph. No steps. No range changes. Just seamless speed to match your every need.



### Tailored transmission settings

The multi-award winning Auto Command™ continuously variable transmission now features a three-stage acceleration and deceleration setting. The “soft” setting is suitable for gentle direction changes, perfect during high-speed transport or when working on slippery surfaces. The standard setting has been designed for normal field activities. The super-fast aggressive setting is ideal when near-instantaneous direction changes are required.



### Active stop start

A key safety feature of Auto Command™ is Active StopStart. When the tractor is brought to a standstill, the transmission prevents the tractor from moving backwards or forwards, even with a heavy load. An electronic brake is easily engaged via the shuttle lever.



### Balancing fuel economy and productivity

When working in Auto and Cruise modes, use the droop control setting. It can be adjusted in the transmission setup screen of the IntelliView™ 12 display or by accessing this setup screen via the quick key button on the SideWinder™ Ultra armrest to limit the upper engine speed used to achieve the desired forward speed. The result: you reach target speed at much lower engine revs, saving you fuel. In PTO mode, use droop control to regulate the acceptable reduction in PTO speed before forward speed is reduced.

# Traction without question.

New GENESIS® T8 tractors have the longest wheelbase in the segment. Ultra Command™ models boast a 135 inch wheelbase, and 139 inch on the T8.435. That is a full 10 inches longer than the nearest competitor. A longer wheelbase means greater stability at high transport speeds, easier ballasting with better weight transfer, and more traction for demanding heavy drawbar applications.





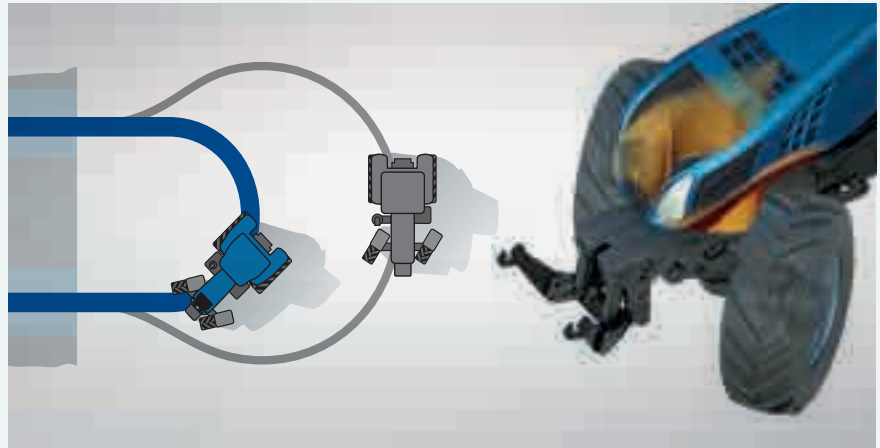

**New Holland GENESIS® T8:  
A wheeled advantage over competing conventional tractors**

**Reduced turning circle.** Mounted far forward, the front axle is matched to a tapered engine hood. This allows the hubs to turn to a full lock of 55 degrees, even when large front tyres or dual wheels are fitted.

**Class-leading maneuverability.** With a turn radius of just over 16 feet, a wheeled GENESIS® T8 tractor can turn tighter and return to work faster.



**Heavy-duty axles for heavy-duty performance**

The heavy-duty axle is fitted to the T8.435 as standard. The 5 inch bar axle is designed to cope with the massive power and torque developed from the Cursor 9 engine and transmit it into tractive force. It can also accommodate the largest 2.15 m tyres, such as the 900/60R42 option.

# More stable transport. Smoother in-field performance.

---

GENESIS® T8 tractors feature rugged front axles in line with its 22-ton gross vehicle weight, which means that you can work with even heavier attachments with ease. A standard feature, the Terraglide™ front axle suspension with its twin dampers and accumulators delivers a silky smooth ride. The engine and subframe have been designed to maximise turning performance, so that the front wheels come in tight against the sculpted front for tight turning.





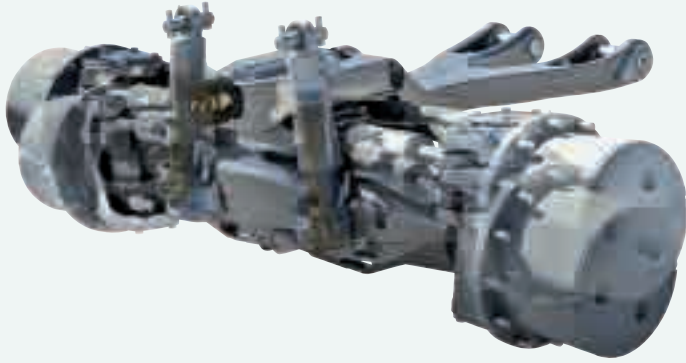

### **Terraglide™ front axle suspension**

The New Holland Terraglide™ front axle suspension is proven to protect the tractor, mounted implements and the operator from heavy shock loads during transport and in the field. In the field the advanced suspension system maintains contact between the tyre and the ground to improve traction. Full suspension travel is always maintained thanks to the system adapting to changes in the weight applied to the front of the tractor.



### **All-new Semi-Active Comfort Ride™ cab suspension**

To ensure the smoothest ride, the optional Semi-Active cab suspension system uses a network of sensors which monitor cab position, velocity and acceleration, together with cab pitch and roll to automatically adjust the individually controlled hydro-pneumatic rear cab suspension struts. The operator can select from three different modes: normal, soft (to absorb large bumps, ideal when working in soft and rough terrain at slow speeds), or hard (ideal for working at higher speeds and during road transport).



### **Advanced traction management**

The New Holland Terralock™ system enables the operator to simply select the traction package needed for a specific application. Terralock will then manage drive to the front axle and engage and release the differential locks automatically. During a headland turn or moving from work to transport, Terralock will unlock the differentials and 4WD without operator intervention.



# SmartTrax™. The half-track advantage.

---

GENESIS® T8 models with SmartTrax™ rubber tracks represent a key advance in conventional tractor design, combining the in-field advantages of a wheeled tractor with the flotation and traction benefits of a tracked machine. Factory developed specifically for the GENESIS® T8 Series and available on T8.410 and T8.435 models, SmartTrax are not simply a “bolt-on” alternative to rear wheels. Detailed modifications to the transmission and driveline ensure maximum power and torque can be transmitted to the tracks for dependable performance in the most demanding of applications.

## **Comfort as standard**

Solid tracks cannot deliver the same cushioning from shock loads as a tyre. With GENESIS® T8 with SmartTrax, the optional, specially tuned suspended front axle and standard cab suspension help to cushion the ride for a genuine comfort advantage over a twin-track machine.





### Contour following

Over uneven terrain, the pivoting SmartTrax undercarriage can articulate to follow the ground. The result? Continuous soil contact and the ability to work in diverse conditions and terrain for true New Holland versatility.

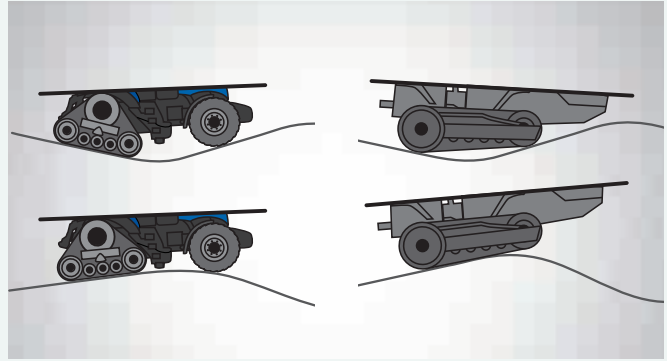

### Terralock™ advantage

The combination of driven front wheels and SmartTrax deliver outstanding traction. Powered front wheels deliver the agility of a conventional tractor while the Terralock™ differential lock management system ensures the tractor stays on line in work, without snaking in slippery patches, unlike twin-track machines. In high-draft applications, a GENESIS® T8 with SmartTrax delivers the optimum balance between power and performance.



### Start earlier, stay later

Get going sooner, keep working longer. A lighter footprint has obvious advantages in helping to reduce compaction. But it delivers more. With SmartTrax you can start working earlier and stay working later in conditions that could compromise a twin-track tractor. Productivity and soil care can go hand in hand.

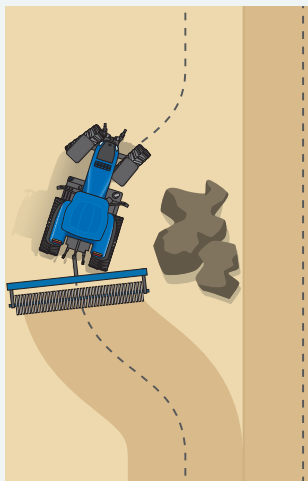

### Full power turns

When working on headlands or around obstacles — where an element of turning is required with the implement still in the ground — SmartTrax has the advantage of allowing full power to be maintained throughout the turn. With SmartTrax, forward motion is not compromised by steering.

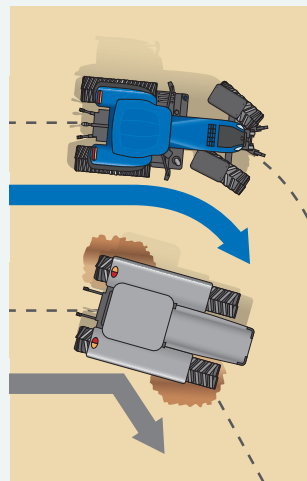

### Turn without the berm

During a tight headland turn, a tracklayer can cause damage to the soil, creating a "berm" ridge. With SmartTrax, tight turns are cleaner and less damaging. The result: no more rough headlands.

## On the right track.

New Holland's SmartTrax™ rubber track technology is the fruit of many years of intensive research and development in collaboration with farmers the world over. SmartTrax™ feature some of the most advanced technology to ensure they deliver in your fields. Day in. Day out. All year round.



Ductile cast iron drive wheel

Clear bearing caps to view oil level

Automatic hydraulic track-tensioning system

3 idler bogies with rubber suspension mounts

7-8 lug positive engagement with drive wheel



### High flotation

The ground contact area of a SmartTrax™ track will be up to 325% greater than a tyre. A bigger and longer footprint delivers better traction in sandy or tilled soil conditions.

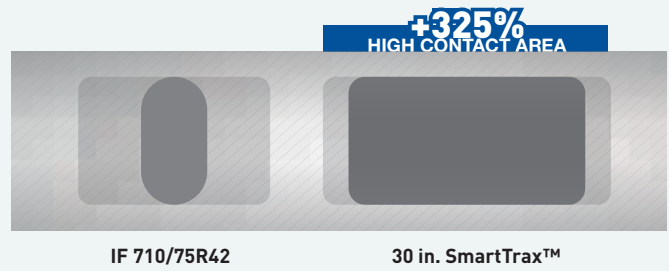

### Track width

SmartTrax™ can be fitted with tracks of 16, 18, 21, 24 and 30-inch widths. From row crop to broad acre farming, there is a SmartTrax option to fit your specific needs.

### Track spacing

New Holland offers a variety of track options, with track settings from 76 inches, allowing use beyond just row crop applications.

SmartTrax™ track size	16"	18"	21"	24"	30"
76 in. spacing (Factory)	●	●	●	●	–
80 in. spacing (Factory)	●	●	●	●	–
88 in. spacing (Factory)	●	●	●	●	●
120 in. spacing (Factory)	●	●	●	●	●*
136 in. spacing (DIA)	●	●	●	●	●
144 in. spacing (DIA)	●	●	●	●	●
152 in. spacing (DIA)	●	●	●	●	●

● Available – Not available

\* Not available from factory, but are available as a Dealer Installed Accessory (DIA)

# Super-safe, super-stable transport.

For today's modern farmers and contractors, high-speed transport is a fundamental part of daily life. Whether you are travelling between clients or between distant fields, you will appreciate the impressive road handling of a GENESIS® T8 tractor. Outstanding visibility, precision Auto Command™ speed control and a range of braking options make it a true road cruiser.

## Brake assist for tighter turning

In order to deliver enhanced turning performance, the brake assist feature has been developed for GENESIS® T8 tractors. As soon as the turn is initiated, a controlled braking force is applied to the rear inside wheel to assist in delivering tighter turns.

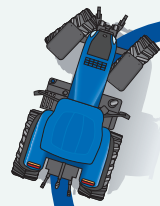





### CustomSteer™ variable ratio steering

The optional CustomSteer™ function puts you in control of steering wheel inputs. Through the IntelliView™ 12 monitor or via a dedicated switch, you can control how many turns of the wheel are required for lock-to-lock functionality. If you want to perform tight turns, say when turning on the headland, you can program the tractor to deliver lock-to-lock turning with as few as one complete steering wheel revolution instead of the standard four, saving you time and effort.



### Safe braking technology

The GENESIS® T8 is equipped with an engine exhaust brake that is activated by a foot pedal. The Auto Command transmission ratio can also be manually locked while braking for added safety. Pushing the shuttle button on the CommandGrip™ multifunction handle in the direction of travel will lock the transmission ratio. This provides increased engine braking, but also allows the tractor and trailer to slow at the same rate, avoiding the risk of a jack-knife situation on slippery surfaces.



### Tyre pressure monitoring system

Operators can check the pressure of up to 16 tyres with the tyre pressure monitoring system (TPMS). Sensors on each tyre transmit via wireless to an antenna within the cab roof. For each tyre the operator can input the ideal working pressure for a specific task. The pressure values are saved against the implement name within the IntelliView™ 12 monitor, so you only need to store settings once. An on-screen warning then alerts the operator if the pressures are not in line with the ideal value. The TPMS benefits operational efficiency, warning if the pressures are set incorrectly, and provides an early warning of any potential punctures on a trailer, for example.

## Ready for modern demands.

The GENESIS® T8 Series features impressive front and rear hitch capacity, which means it can work with the very largest front- and rear-mounted equipment to enhance your productivity. Want to use the largest plows? Then the beefy rear hitch is perfect. If you're a potato farmer or you need to mount the very heaviest seed hoppers, then the fully-integrated front hitch is for you. Available in both category III and IV, and with a variety of drawbar options and sliding hitches, your tractor can be specified to suit your specific requirements.



### Strong, efficient and powerful

The maximum lift capacity on GENESIS® T8 tractors is a massive 24,089 lbs. The system also incorporates integral dynamic ride control shock-load protection. This will reduce bounce when travelling with a heavy hitch load at transport speeds. Fender-mounted controls for the rear hitch, a rear remote and the PTO are available.



### Factory-fitted front hitch and PTO

The slim engine hood provides excellent forward visibility. The balanced wheelbase makes it even easier to make full use of the hitch's 12,809 lb. lift capacity. Integrated electronic front hitch controls are within easy reach of the operator.





### **Flexible ballasting**

Thanks to the optional weight packages, ballasting is now even easier. You can choose between a wide range of front ballasting options to perfectly suit each individual application. They can be quickly fitted and simply removed thanks to the dedicated pallet fork slots.

# Features to boost your productivity.

GENESIS® T8 tractors offer exceptional heavy-draft performance, which is a key demand of tractors developing more than 400 hp (CV). And that's just the start. PTO and hydraulic performance is maintained, even in demanding conditions, thanks to the constant power curve, resulting in massive performance with optimum economy. These tractors reach rated PTO speed at reduced engine speed for maximum fuel efficiency. Versatility comes standard with a GENESIS® T8.

## Direct drive for fuel efficiency

All GENESIS® T8 tractors are fitted with a direct drive PTO to minimise power loss between the engine and the implement. The PTO is engaged via a forward sliding switch, with advanced Soft Start management. This modulates engagement of high-inertia attachments to protect the driveline and provide smooth engagement of implements. Safety has been further enhanced with the inclusion of an intentional PTO switch, which must be selected to keep the PTO engaged when leaving the operators seat. Additional PTO options include Auto PTO that can be selected to automatically disengage the PTO as the front or rear hitch is raised above a pre-set position. This protects the PTO shaft and tractor.



## PTO

A front-mounted 1,000-rpm PTO is available, while at the rear either a 540/1,000 rpm or 1,000 rpm PTO is offered. PTO management is integrated into the Headland Turn Sequencing II system.





### **Headland Turn Sequencing II system: hassle-free repeatability**

The intuitive HTS II system means you can easily record and store all implement sequences and operations at the headland. These can then be played back at the touch of a button. Now it's even easier to modify pre-recorded sequences, so when things change, your HTS sequence does as well! HTS II is a great way to improve repeatability and efficiency as well as to reduce fatigue when working over extended periods.



# Hydraulic power.

---

All GENESIS® T8 tractors are fitted with an advanced Closed Centre Load Sensing hydraulic system as standard. Delivering 214 lpm as standard, which is enough to power the majority of farming applications. For the most hydraulically demanding customers, the MegaFlow™ option offers an impressive 282 lpm of flow. If that wasn't enough, New Holland has engineered the CCLS system to operate at peak efficiency.

The benefit? Full hydraulic power is always available at the remote valves and hitch, but only as much as is needed. The result? Reduced fuel consumption.







### Hydraulic remote valve management

It is now even easier to control hydraulic functions, as each hydraulic remote valve is indicated by a coloured LED paddle. The remote paddle position on the SideWinder™ Ultra armrest is completely configurable, so operators can choose which paddle operates which hydraulic remote. This makes it easier to customise usage based on application and operator preference.



### Quick and simple flow control setting

The IntelliView™ 12 touchscreen monitor makes setting flow rates to individual valves simple. Scroll through the menus and select valve control. Choose the outlet you wish to adjust, and drag the slider with your finger to the desired setting or use the front armrest encoder wheel. Job done.



### Up to 9 configurable electronic remotes

GENESIS® T8 remote valves are easy to identify with colour-coded couplers and levers. All nine remotes can be controlled from the SideWinder™ Ultra armrest, allowing you to identify and work each remote with exact precision. Five remote levers are on the armrest and two valves are controlled by either using the two additional paddles located to the right of the IntelliView™ 12 monitor, the CommandGrip™ handle or the electronic joystick, which can now control up to six remotes. Flow, timing and detent settings can be set to precisely match the job.

# 360°: GENESIS® T8 tractors.

GENESIS® T8 tractors have been designed to spend more time working and less time requiring service. All service points are easy to access, and super-long service intervals mean your tractor will spend more time in its natural environment: the field!

A built-in step makes reaching the front screen for cleaning safe and secure.

Single-piece engine hood opens wide for full-service access.

Cooling package opens out to make cleaning faster and easier.

Engine and hydraulic oil check and fill points are easy to reach, making routine checks fast and servicing simpler.







The engine air filter is easy to check, clean or replace, with no need for tools from ground level.

Fill the windshield wash bottle through the rear window.

Changing the cab air filter is easy.

Models		T8.320	T8.350	T8.380	T8.410
<b>Engine*</b>		<b>FPT Cursor 9</b>	<b>FPT Cursor 9</b>	<b>FPT Cursor 9</b>	<b>FPT Cursor 9</b>
No. of cylinders / Aspiration / Valves / Emission level		6/WT/24/Tier 2	6/eVGT/24/Tier 2	6/eVGT/24/Tier 2	6/eVGT/24/Tier 2
Fuel System – high pressure common rail		●	●	●	●
Displacement	cubic in. (L)	531 [8.7]	531 [8.7]	531 [8.7]	531 [8.7]
Max. EPM horsepower** – ISO – ECE R120, 1800 rpm	kW/hp (CV)	235 / 320	258 / 351	281 / 381	301 / 409
Max. horsepower – ISO – ECE R120, 1800 rpm	kW/hp (CV)	209 / 284	232 / 315	255 / 347	275 / 374
Rated EPM horsepower – ISO – ECE R120, 2000 rpm	kW/hp (CV)	210 / 286	232 / 315	255 / 347	276 / 375
Rated horsepower – ISO – ECE R120, 2000 rpm	kW/hp (CV)	184 / 250	206 / 280	229 / 311	250 / 340
PTO HP (SAE)	kW/hp (CV)	153 / 205	175 / 235	198 / 265	216 / 290
Viscous coupled cooling fan		●	●	●	●
Diesel capacity Auto Command CVT (full to drained)	gal. (L)	163 [617]	163 [617]	163 [617]	163 [617]
Diesel capacity Ultra Command FPS (full to drained)	gal. (L)	179 [678]	179 [678]	179 [678]	179 [678]
Service Interval	hours	600	600	600	600
<b>Ultra Command™ Full-Powershift transmission</b>					
18 x 4 Ultra Command™ Full-Powershift (40 kph)		○	○	○	○
19 x 4 Ultra Command™ Full-Powershift (40 kph ECO or 50 kph)		●	●	●	●
23 x 6 Ultra Command™ Full-Powershift (40kph with Creeper)		○	○	○	○
<b>Auto Command™ Continuously Variable Transmission (CVT)</b>					
Auto Command™ Continuously Variable Transmission [40kph]		●	●	●	●
Auto Command™ Continuously Variable Transmission [50kph]		●	●	●	●
<b>Electrical</b>					
12 volt alternator	amps	240	240	240	240
Batteries		2–12 V	2–12 V	2–12 V	2–12 V
<b>Axles</b>					
Rear axle dimension standard/optional	in. (mm)	4/4.5 [102/114]	4/4.5 [102/114]	4.5 [114]	5 [127]
Rear axle length	in. (mm)	120 [3050]	120 [3050]	120 [3050]	120 [3050]
Terraglide™ front axle suspension		●	●	●	●
MFD tread adjustability	in. (mm)	60–88 [1524–2235]	60–88 [1524–2235]	60–88 [1524–2235]	60–88 [1524–2235]
Track Spacing (center to center)	in. (mm)	–	–	–	–
<b>Hydraulics</b>					
System type		Pressure–flow compensating (PFC)			
Standard pump flow	gpm (Lpm)	56 [214]	56 [214]	56 [214]	56 [214]
MegaFlow™ option	gpm (Lpm)	75 [282]	75 [282]	75 [282]	75 [282]
<b>Remote Valves</b>					
Type		Electro hydraulic	Electro hydraulic	Electro hydraulic	Electro hydraulic
Remotes – Electro–hydraulic	STD (opt)	4 (up to 9)	4 (up to 9)	4 (up to 9)	4 (up to 9)
<b>Hitch</b>					
Rear hitch category	lbs. (kg)	Cat III/IIIN	Cat III/IIIN – Cat IVN/III	Cat III/IIIN – Cat IVN/III	Cat IVN/III
Cat III/IIIN Lift capacity 43"links/38" links, 4" rear axle	lbs. (kg)	12,900 [5851] / 14,900 [6758]		–	–
Cat III/IIIN Lift capacity 43"links/38" links, 4.5" rear axle	lbs. (kg)	15,900 [7212] – 19,500 [8119]			
Cat IVN/III Lift capacity 43"links/38" links, 4.5" rear axle	lbs. (kg)	–	17,500 [7938] / 19,500 [8845]		
Cat HD IVN/III, 5" rear axle	lbs. (kg)	–	–	–	–
Front hitch lift capacity (610 mm in front of ball ends)		12,800 [5810]	12,800 [5810]	12,800 [5810]	12,800 [5810]
<b>PTO</b>					
Front PTO/ 3–point hitch	lbs. (kg)	○	○	○	○
Front hitch lift capacity		12,800 [5810]	12,800 [5810]	12,800 [5810]	12,800 [5810]
Front PTO and shaft size		1000 rpm, 1 3/8" , 21 spine			
<b>Cab</b>					
Comfort Ride™ cab suspension		●	●	●	●
IntelliSteer® guidance complete		●	●	●	●
Cab sound level	dBA	68	68	68	68
Volume–size	cu. ft. (cu. m)	109.5 (3.1)	109.5 (3.1)	109.5 (3.1)	109.5 (3.1)
Glass	sq. ft. (m sq.)	68.5 [6.4]	68.5 [6.4]	68.5 [6.4]	68.5 [6.4]
<b>Estimated average standard weight***</b>	lbs. (kg)	22,200 [10,070]	22,377 [10,150]	22,487 [10,200]	22,663 [10,280]
<b>Max Ballasting</b>	lbs. (kg)	27,734 [12,580]	31,791 [14,420]	35,847 [16,260]	39,150 [17,800]

● Standard ○ Optional – Not available \* Developed by FPT Industrial \*\* Power boost available during mobile PTO, hydraulic or transport speeds  
 \*\*\* Weight is based on tractor equipped with standard equipment, minimum fuel, no ballast, no operator and single wheel equipment



T8.435	T8.410 SMARTTRAX	T8.435 SMARTTRAX
<b>FPT Cursor 9</b>	<b>FPT Cursor 9</b>	<b>FPT Cursor 9</b>
6/eVGT/24/Tier 2	6/eVGT/24/Tier 2	6/eVGT/24/Tier 2
●	●	●
531 [8.7]	531 [8.7]	531 [8.7]
320 / 435	301 / 409	320 / 435
307 / 417	275 / 374	307 / 417
305 / 415	276 / 375	305 / 415
279 / 380	250 / 340	279 / 380
235 / 315	216 / 290	235 / 315
●	●	●
163 [617]	163 [617]	163 [617]
-	179 [678]	-
600	600	600
○	●	●
●	-	-
-	-	-
○	○	○
●	●	●
●	-	-
240	240	240
2-12 V	2-12 V	2-12 V
5 [127]	-	-
120 [3050]	-	-
●	●	●
60-88 [1524-2235]	-	-
-	76-152 [1930-3861]	76-152 [1930-3861]
Pressure-flow compensating (PFC)		
56 [214]	56 [214]	56 [214]
75 [282]	73 [274]	73 [274]
Electro hydraulic	Electro hydraulic	Electro hydraulic
4 (up to 9)	4 (up to 9)	4 (up to 9)
Cat HD IVN/III	Cat IVN/III	Cat HD IVN/III
-	-	-
-	-	-
-	-	-
19,900 [9026]	19,900 [9026]	19,900 [9026]
12,800 [5810]	12,800 [5810]	12,800 [5810]
○	○	○
12,800 [5810]	12,800 [5810]	12,800 [5810]
1000 rpm, 1 3/8" , 21 spine		
●	●	●
●	●	●
68	69	69
109.5 [3.1]	109.5 [3.1]	109.5 [3.1]
68.5 [6.4]	68.5 [6.4]	68.5 [6.4]
26,191 [11,880]	35,788 [16,233]	35,788 [16,233]
41,170 [18700]	39,150 [17,800]	41,170 [18700]



# NEW HOLLAND. A REAL SPECIALIST IN YOUR AGRICULTURAL BUSINESS.



AT YOUR OWN DEALER



YOUR SUCCESS – OUR SPECIALTY

Visit our web site at: [www.newholland.com](http://www.newholland.com) - tel: +61 2 9673 7777  
31-53 Kurrajong Road, St Marys NSW 2760



Safety begins with a thorough understanding of the equipment. Always make sure you and your operators read the Operator's Manual before using the equipment. Pay close attention to all safety and operating decals and never operate machinery without all shields, protective devices and structures in place.

The data indicated in this folder are approximate. The models described here can be subjected to modifications without any notice by the manufacturer. The drawings and photos may refer to equipment that is either optional or intended for other countries. Please apply to our Sales Network for any further information. Published by New Holland Brand Communications. - Printed in Australia - XXXXXXXX